

Medium size enclosure for immersion heater, finned heaters or controls

Size(mm)	Volume(cm ³)	Material	Protection grade		Model
66 x 89 x 114	650	Aluminum	IP69K	IK10	Y3P3 (P1)

Suitable for
<input type="checkbox"/> Temperature sensor
<input checked="" type="checkbox"/> Immersion heater
<input checked="" type="checkbox"/> Finned heater
<input checked="" type="checkbox"/> Thermostat
<input type="checkbox"/> Level sensor
<input checked="" type="checkbox"/> Electronic board

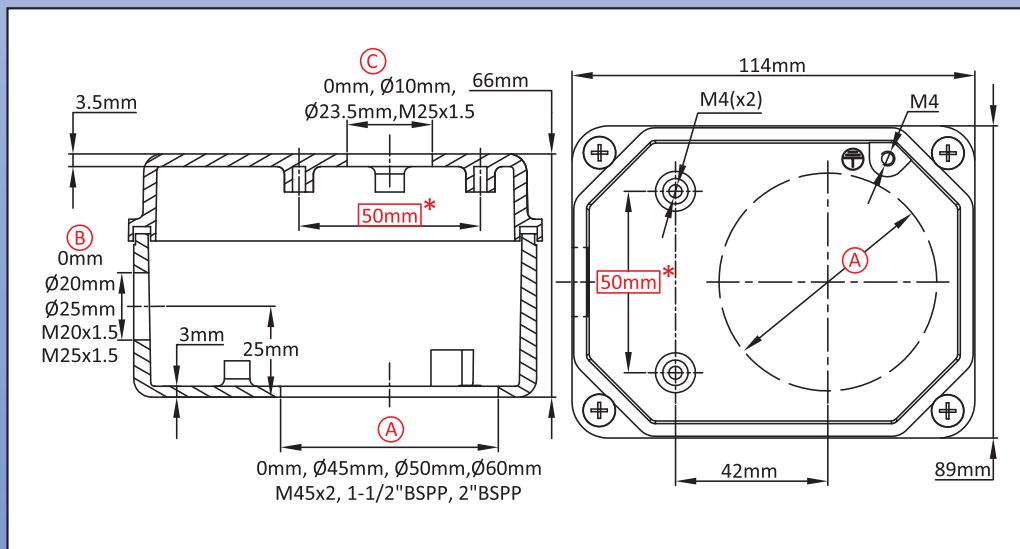

Links

Page (.pdf)

Drawing 2D (.dwg)

Drawing 3D (.stp)

Main references

(A) (mm)	(B) (mm)	(C) (mm)	Not painted	Painted	(A) (mm)	(B) (mm)	(C) (mm)	Not painted	Painted
0	0	0	Y3P3000000000007	Y3P3000000000000G	0	M25x1.5	0	Y3P300001T500007	Y3P300001T50000G
0	0	10	Y3P3000A00000007	Y3P3000A0000000G	0	M25x1.5	10	Y3P3000A1T500007	Y3P3000A1T50000G
0	0	23.5	Y3P3000D00000007	Y3P3000D0000000G	0	M25x1.5	23.5	Y3P3000D1T500007	Y3P3000D1T50000G
0	0	M25x1.5	Y3P3000F00000007	Y3P3000F0000000G	0	M25x1.5	M25x1.5	Y3P3000F1T500007	Y3P3000F1T50000G
0	20	0	Y3P3000012000007	Y3P300001200000G	45	0	0	Y3P3450000000007	Y3P345000000000G
0	20	10	Y3P3000A12000007	Y3P3000A1200000G	45	0	10	Y3P3450A00000007	Y3P3450A0000000G
0	20	23.5	Y3P3000D12000007	Y3P3000D1200000G	45	0	23.5	Y3P3450D00000007	Y3P3450D0000000G
0	20	M25x1.5	Y3P3000F12000007	Y3P3000F1200000G	45	0	M25x1.5	Y3P3450F00000007	Y3P3450F0000000G
0	25	0	Y3P3000012500007	Y3P300001250000G	45	20	0	Y3P3450012000007	Y3P345001200000G
0	25	10	Y3P3000A12500007	Y3P3000A1250000G	45	20	10	Y3P3450A12000007	Y3P3450A1200000G
0	25	23.5	Y3P3000D12500007	Y3P3000D1250000G	45	20	23.5	Y3P3450D12000007	Y3P3450D1200000G
0	25	M25x1.5	Y3P3000F12500007	Y3P3000F1250000G	45	20	M25x1.5	Y3P3450F12000007	Y3P3450F1200000G
0	M20x1.5	0	Y3P300001T000007	Y3P300001T00000G	45	25	0	Y3P3450012500007	Y3P345001250000G
0	M20x1.5	10	Y3P3000A1T000007	Y3P3000A1T00000G	45	25	10	Y3P3450A12500007	Y3P3450A1250000G
0	M20x1.5	23.5	Y3P3000D1T000007	Y3P3000D1T00000G	45	25	23.5	Y3P3450D12500007	Y3P3450D1250000G
0	M20x1.5	M25x1.5	Y3P3000F1T000007	Y3P3000F1T00000G	45	25	M25x1.5	Y3P3450F12500007	Y3P3450F1250000G

Cable gland not included in these reference, consult us if you want them.
 Red dimensions inside rectangular frames are used for accessories assembly.

Because of permanent improvement of our products, drawings, descriptions, features used on these data sheets are for guidance only and can be modified without prior advice



Medium size enclosure for immersion heater, finned heaters or controls

**Y3P3
(P2)**

(A) (mm)	(B) (mm)	(C) (mm)	Not painted	Painted	(A) (mm)	(B) (mm)	(C) (mm)	Not painted	Painted
45	M20x1.5	0	Y3P345001T000007	Y3P345001T00000G	M45x2	20	23.5	Y3P3M45D12000007	Y3P3M45D1200000G
45	M20x1.5	10	Y3P3450A1T000007	Y3P3450A1T00000G	M45x2	20	M25x1.5	Y3P3M45F12000007	Y3P3M45F1200000G
45	M20x1.5	23.5	Y3P3450D1T000007	Y3P3450D1T00000G	M45x2	25	0	Y3P3M45012500007	Y3P3M4501250000G
45	M20x1.5	M25x1.5	Y3P3450F1T000007	Y3P3450F1T00000G	M45x2	25	10	Y3P3M45A12500007	Y3P3M45A1250000G
45	M25x1.5	0	Y3P345001T500007	Y3P345001T50000G	M45x2	25	23.5	Y3P3M45D12500007	Y3P3M45D1250000G
45	M25x1.5	10	Y3P3450A1T500007	Y3P3450A1T50000G	M45x2	25	M25x1.5	Y3P3M45F12500007	Y3P3M45F1250000G
45	M25x1.5	23.5	Y3P3450D1T500007	Y3P3450D1T50000G	M45x2	M20x1.5	0	Y3P3M4501T000007	Y3P3M4501T00000G
45	M25x1.5	M25x1.5	Y3P3450F1T500007	Y3P3450F1T50000G	M45x2	M20x1.5	10	Y3P3M45A1T000007	Y3P3M45A1T00000G
50	0	0	Y3P35000000000007	Y3P3500000000000G	M45x2	M20x1.5	23.5	Y3P3M45D1T000007	Y3P3M45D1T00000G
50	0	10	Y3P3500A00000007	Y3P3500A0000000G	M45x2	M20x1.5	M25x1.5	Y3P3M45F1T000007	Y3P3M45F1T00000G
50	0	23.5	Y3P3500D00000007	Y3P3500D0000000G	M45x2	M25x1.5	0	Y3P3M4501T500007	Y3P3M4501T50000G
50	0	M25x1.5	Y3P3500F00000007	Y3P3500F0000000G	M45x2	M25x1.5	10	Y3P3M45A1T500007	Y3P3M45A1T50000G
50	20	0	Y3P3500012000007	Y3P350001200000G	M45x2	M25x1.5	23.5	Y3P3M45D1T500007	Y3P3M45D1T50000G
50	20	10	Y3P3500A12000007	Y3P3500A1200000G	M45x2	M25x1.5	M25x1.5	Y3P3M45F1T500007	Y3P3M45F1T50000G
50	20	23.5	Y3P3500D12000007	Y3P3500D1200000G	1½" BSPP	0	0	Y3P3BA2000000007	Y3P3BA200000000G
50	20	M25x1.5	Y3P3500F12000007	Y3P3500F1200000G	1½" BSPP	0	10	Y3P3BA2A00000007	Y3P3BA2A0000000G
50	25	0	Y3P3500012500007	Y3P350001250000G	1½" BSPP	0	23.5	Y3P3BA2D00000007	Y3P3BA2D0000000G
50	25	10	Y3P3500A12500007	Y3P3500A1250000G	1½" BSPP	0	M25x1.5	Y3P3BA2F00000007	Y3P3BA2F0000000G
50	25	23.5	Y3P3500D12500007	Y3P3500D1250000G	1½" BSPP	20	0	Y3P3BA2012000007	Y3P3BA201200000G
50	25	M25x1.5	Y3P3500F12500007	Y3P3500F1250000G	1½" BSPP	20	10	Y3P3BA2A12000007	Y3P3BA2A1200000G
50	M20x1.5	0	Y3P350001T000007	Y3P350001T00000G	1½" BSPP	20	23.5	Y3P3BA2D12000007	Y3P3BA2D1200000G
50	M20x1.5	10	Y3P3500A1T000007	Y3P3500A1T00000G	1½" BSPP	20	M25x1.5	Y3P3BA2F12000007	Y3P3BA2F1200000G
50	M20x1.5	23.5	Y3P3500D1T000007	Y3P3500D1T00000G	1½" BSPP	25	0	Y3P3BA2012500007	Y3P3BA201250000G
50	M20x1.5	M25x1.5	Y3P3500F1T000007	Y3P3500F1T00000G	1½" BSPP	25	10	Y3P3BA2A12500007	Y3P3BA2A1250000G
50	M25x1.5	0	Y3P350001T500007	Y3P350001T50000G	1½" BSPP	25	23.5	Y3P3BA2D12500007	Y3P3BA2D1250000G
50	M25x1.5	10	Y3P3500A1T500007	Y3P3500A1T50000G	1½" BSPP	25	M25x1.5	Y3P3BA2F12500007	Y3P3BA2F1250000G
50	M25x1.5	23.5	Y3P3500D1T500007	Y3P3500D1T50000G	1½" BSPP	M20x1.5	0	Y3P3BA201T000007	Y3P3BA201T00000G
50	M25x1.5	M25x1.5	Y3P3500F1T500007	Y3P3500F1T50000G	1½" BSPP	M20x1.5	10	Y3P3BA2A1T000007	Y3P3BA2A1T00000G
60	0	0	Y3P36000000000007	Y3P3600000000000G	1½" BSPP	M20x1.5	23.5	Y3P3BA2D1T000007	Y3P3BA2D1T00000G
60	0	10	Y3P3600A00000007	Y3P3600A0000000G	1½" BSPP	M20x1.5	M25x1.5	Y3P3BA2F1T000007	Y3P3BA2F1T00000G
60	0	23.5	Y3P3600D00000007	Y3P3600D0000000G	1½" BSPP	M25x1.5	0	Y3P3BA201T500007	Y3P3BA201T50000G
60	0	M25x1.5	Y3P3600F00000007	Y3P3600F0000000G	1½" BSPP	M25x1.5	10	Y3P3BA2A1T500007	Y3P3BA2A1T50000G
60	20	0	Y3P3600012000007	Y3P360001200000G	1½" BSPP	M25x1.5	23.5	Y3P3BA2D1T500007	Y3P3BA2D1T50000G
60	20	10	Y3P3600A12000007	Y3P3600A1200000G	1½" BSPP	M25x1.5	M25x1.5	Y3P3BA2F1T500007	Y3P3BA2F1T50000G
60	20	23.5	Y3P3600D12000007	Y3P3600D1200000G	2" BSPP	0	0	Y3P3BB2000000007	Y3P3BB200000000G
60	20	M25x1.5	Y3P3600F12000007	Y3P3600F1200000G	2" BSPP	0	10	Y3P3BB2A00000007	Y3P3BB2A0000000G
60	25	0	Y3P3600012500007	Y3P360001250000G	2" BSPP	0	23.5	Y3P3BB2D00000007	Y3P3BB2D0000000G
60	25	10	Y3P3600A12500007	Y3P3600A1250000G	2" BSPP	0	M25x1.5	Y3P3BB2F00000007	Y3P3BB2F0000000G
60	25	23.5	Y3P3600D12500007	Y3P3600D1250000G	2" BSPP	20	0	Y3P3BB2012000007	Y3P3BB201200000G
60	25	M25x1.5	Y3P3600F12500007	Y3P3600F1250000G	2" BSPP	20	10	Y3P3BB2A12000007	Y3P3BB2A1200000G
60	M20x1.5	0	Y3P360001T000007	Y3P360001T00000G	2" BSPP	20	23.5	Y3P3BB2D12000007	Y3P3BB2D1200000G
60	M20x1.5	10	Y3P3600A1T000007	Y3P3600A1T00000G	2" BSPP	20	M25x1.5	Y3P3BB2F12000007	Y3P3BB2F1200000G
60	M20x1.5	23.5	Y3P3600D1T000007	Y3P3600D1T00000G	2" BSPP	25	0	Y3P3BB2012500007	Y3P3BB201250000G
60	M20x1.5	M25x1.5	Y3P3600F1T000007	Y3P3600F1T00000G	2" BSPP	25	10	Y3P3BB2A12500007	Y3P3BB2A1250000G
60	M25x1.5	0	Y3P360001T500007	Y3P360001T50000G	2" BSPP	25	23.5	Y3P3BB2D12500007	Y3P3BB2D1250000G
60	M25x1.5	10	Y3P3600A1T500007	Y3P3600A1T50000G	2" BSPP	25	M25x1.5	Y3P3BB2F12500007	Y3P3BB2F1250000G
60	M25x1.5	23.5	Y3P3600D1T500007	Y3P3600D1T50000G	2" BSPP	M20x1.5	0	Y3P3BB201T000007	Y3P3BB201T00000G
60	M25x1.5	M25x1.5	Y3P3600F1T500007	Y3P3600F1T50000G	2" BSPP	M20x1.5	10	Y3P3BB2A1T000007	Y3P3BB2A1T00000G
M45x2	0	0	Y3P3M450000000007	Y3P3M45000000000G	2" BSPP	M20x1.5	23.5	Y3P3BB2D1T000007	Y3P3BB2D1T00000G
M45x2	0	10	Y3P3M45A00000007	Y3P3M45A0000000G	2" BSPP	M20x1.5	M25x1.5	Y3P3BB2F1T000007	Y3P3BB2F1T00000G
M45x2	0	23.5	Y3P3M45D00000007	Y3P3M45D0000000G	2" BSPP	M25x1.5	0	Y3P3BB201T500007	Y3P3BB201T50000G
M45x2	0	M25x1.5	Y3P3M45F00000007	Y3P3M45F0000000G	2" BSPP	M25x1.5	10	Y3P3BB2A1T500007	Y3P3BB2A1T50000G
M45x2	20	0	Y3P3M45012000007	Y3P3M4501200000G	2" BSPP	M25x1.5	23.5	Y3P3BB2D1T500007	Y3P3BB2D1T50000G
M45x2	20	10	Y3P3M45A12000007	Y3P3M45A1200000G	2" BSPP	M25x1.5	M25x1.5	Y3P3BB2F1T500007	Y3P3BB2F1T50000G

Because of permanent improvement of our products, drawings, descriptions, features used on these data sheets are for guidance only and can be modified without prior advice

